



POS-Shop

Masterversion

Nur für internen Bedarf – keine Verkaufsunterlage

Abbildung ähnlich

51.701 POS Shop Premium – hoch



Abbildung ähnlich



Abbildung ähnlich

Lieferumfang

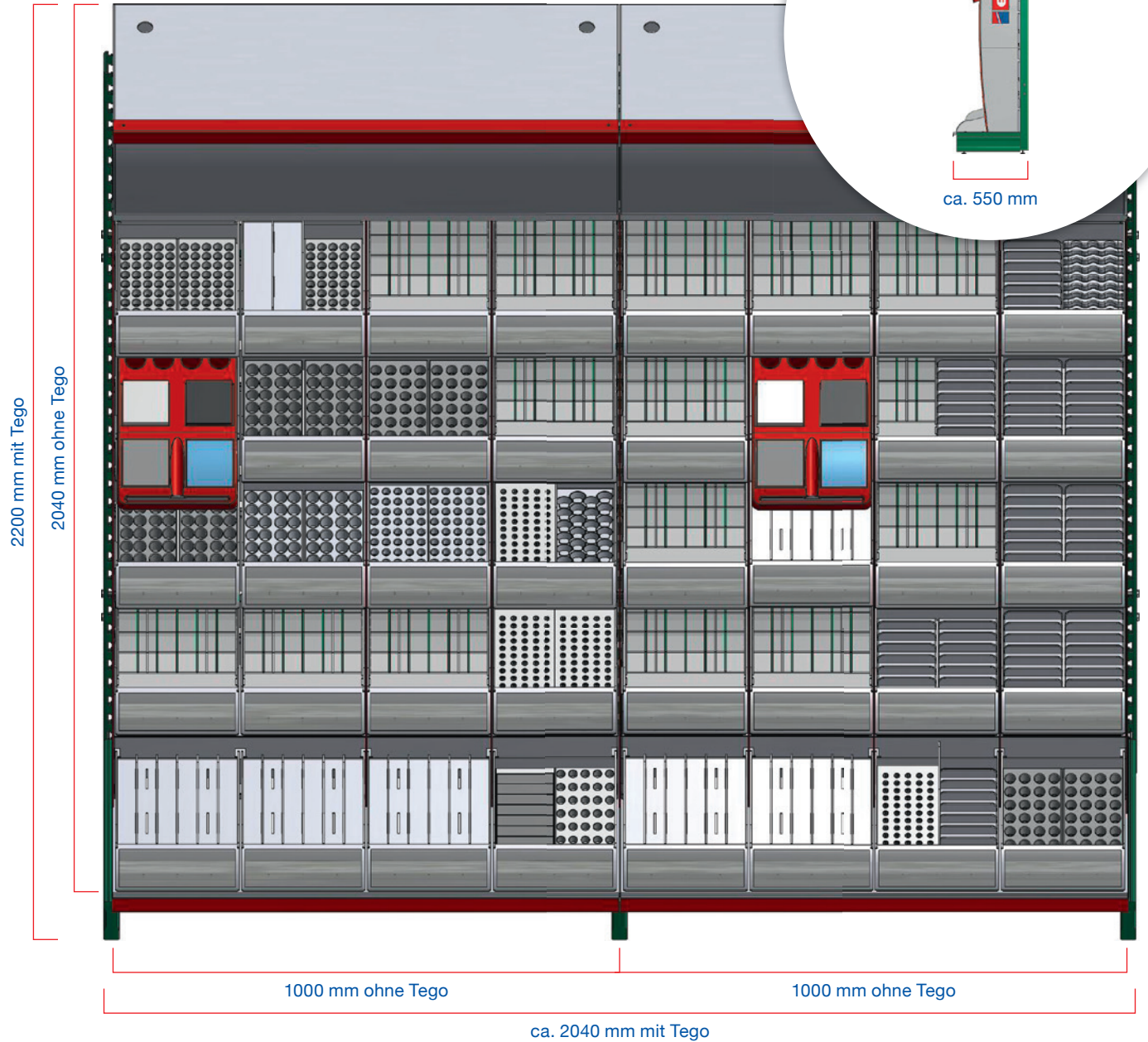
Module (= Tray + Einsätze):

■ POS Modul A 1/1	(x 1)
■ POS Modul B 2/1	(x 1)
■ POS Modul C 16	(x 2)
■ POS Modul D 3	(x 2)
■ POS Modul E 4	(x 1)
■ POS Modul F	(x 12)
■ POS Modul F+FI	(x 2)
■ POS Modul G 5	(x 6)
■ POS Modul H 6	(x 2)
■ POS Modul I 7	(x 1)
■ POS Modul J 8/9	(x 1)
■ POS Modul K 8	(x 1)
■ POS Modul L 10/11	(x 1)
■ POS Modul M 12/13	(x 1)
■ POS Modul N 13/13	(x 4)
■ POS Modul O 8/13	(x 1)
■ POS Modul P 13/14	(x 1)

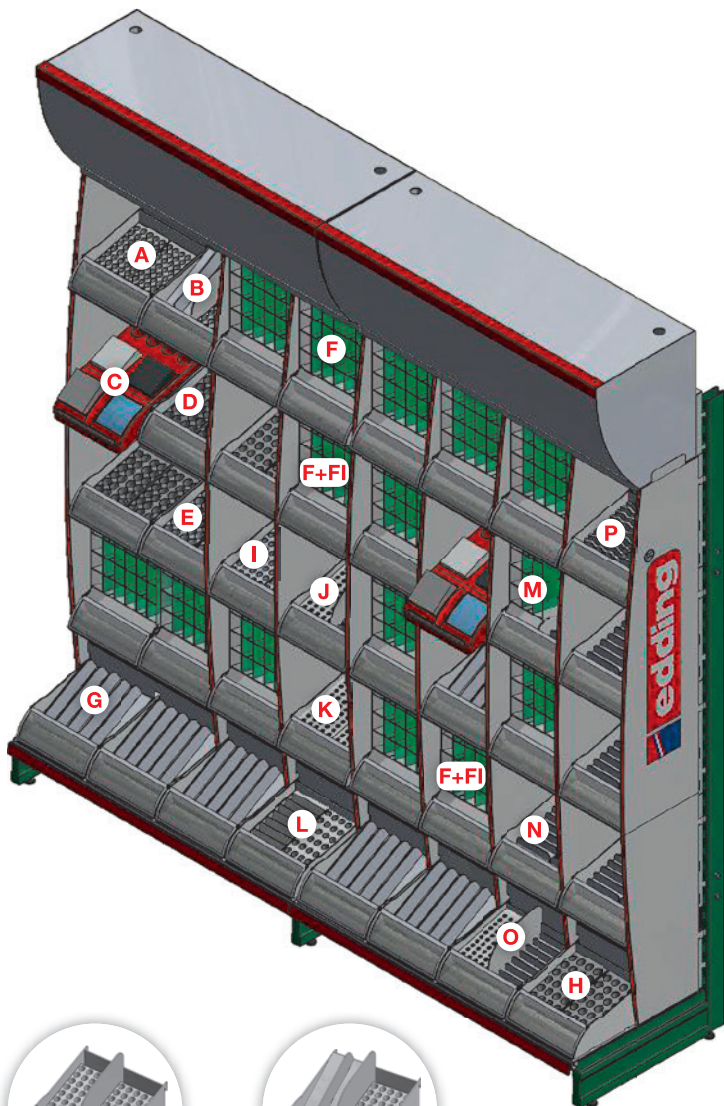
Shopteile:

■ Sockel	(x 2)
■ Rückwand	(x 8)
■ 51.754 Header	(x 2)
■ 51.756 Seitenwand hoch, rechts	(x 1)
■ 51.757 Seitenwand hoch, links	(x 1)
■ 51.777 Innenwand hoch	(x 5)
■ 51.827 Innenwand hoch, Shopmitte	(x 1)
■ 51.752 Schublade hoch	(x 8)
■ Rahmenleiste unten, rot	(x 2)
■ Seitenwandhalterung zur Befestigung am Header	(x 2)
■ Verteilersteckdose, 3-fach	(x 1)

Nicht im Lieferumfang enthalten:

Tego:

- 51.780 Tego für POS Shop – hoch, 2 m breit

Verfügbare Diasätze:

- 51.789 POS Dia **DE** für DE + CH Variante
- 51.790 POS Dia **EN** für Showroom Variante

Verfügbare Etikettensätze:

- 51.809 POS Etikettensatz **DE** für DE Variante
- 51.810 POS Etikettensatz **EN** für Showroom Variante

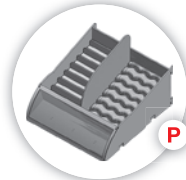
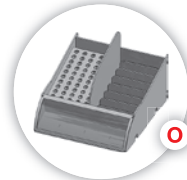
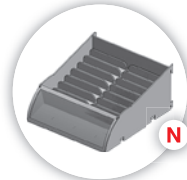
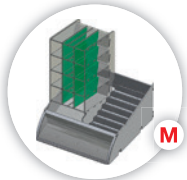
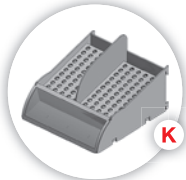
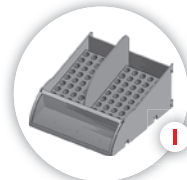
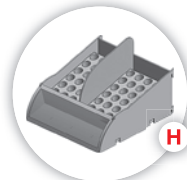
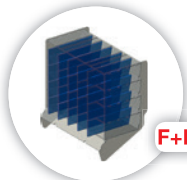
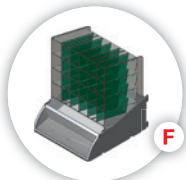
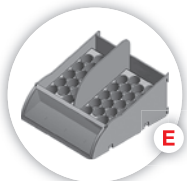
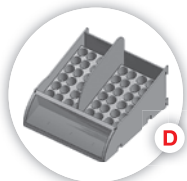
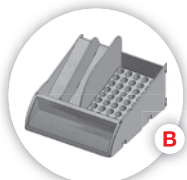
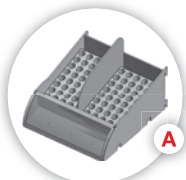

51.700 POS Shop PBS – hoch



Abbildung ähnlich



Abbildung ähnlich

Lieferumfang

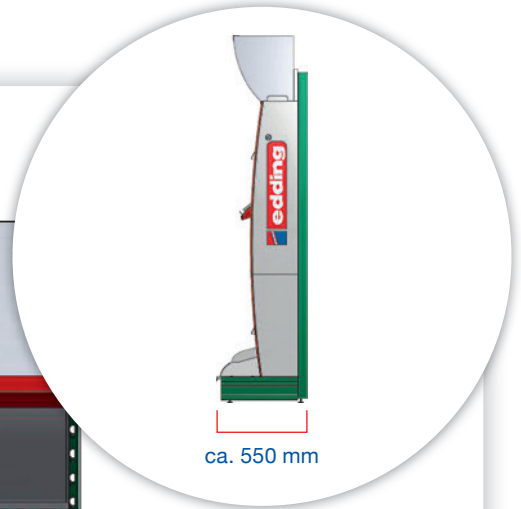
Module (= Tray + Einsätze):

■ POS Modul B 1/2	(x 1)
■ POS Modul C 16	(x 1)
■ POS Modul D 3	(x 1)
■ POS Modul E 4	(x 1)
■ POS Modul F	(x 8)
■ POS Modul F+FI	(x 2)
■ POS Modul G 5	(x 1)
■ POS Modul I 7	(x 1)
■ POS Modul J 8/9	(x 1)
■ POS Modul M 12/13	(x 1)
■ POS Modul O 8/13	(x 1)
■ POS Modul R 12/2	(x 1)

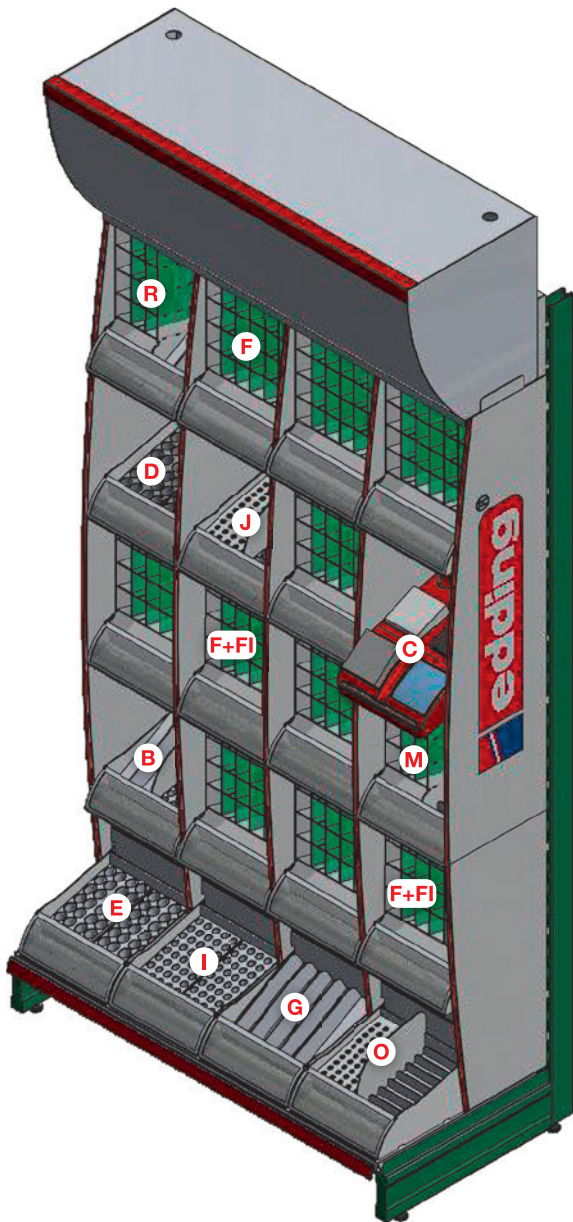
Shopteile:

■ Sockel	(x 1)
■ Rückwand	(x 4)
■ 51.754 Header	(x 1)
■ 51.756 Seitenwand hoch, rechts	(x 1)
■ 51.757 Seitenwand hoch, links	(x 1)
■ 51.777 Innenwand hoch	(x 3)
■ 51.752 Schublade hoch	(x 4)
■ Rahmenleiste unten, rot	(x 1)
■ Seitenwandhalterung zur Befestigung am Header	(x 2)

Nicht im Lieferumfang enthalten:

Tego:

- 51.779 Tego für POS Shop – hoch, 1 m breit

Verfügbare Diasätze:

- 51.785 POS Dia **DE** für DE + CH Variante
- 51.786 POS Dia **EN** für Showroom Variante
- 51.787 POS Dia **FR** für BeNeLux + CH Variante
- 51.788 POS Dia **NL** für BeNeLux Variante

Verfügbare Etikettensätze:

- 51.805 POS Etikettensatz **DE** für DE Variante
- 51.806 POS Etikettensatz **EN** für Showroom Variante
- 51.807 POS Etikettensatz **FR** für BeNeLux Variante
- 51.808 POS Etikettensatz **NL** für BeNeLux Variante

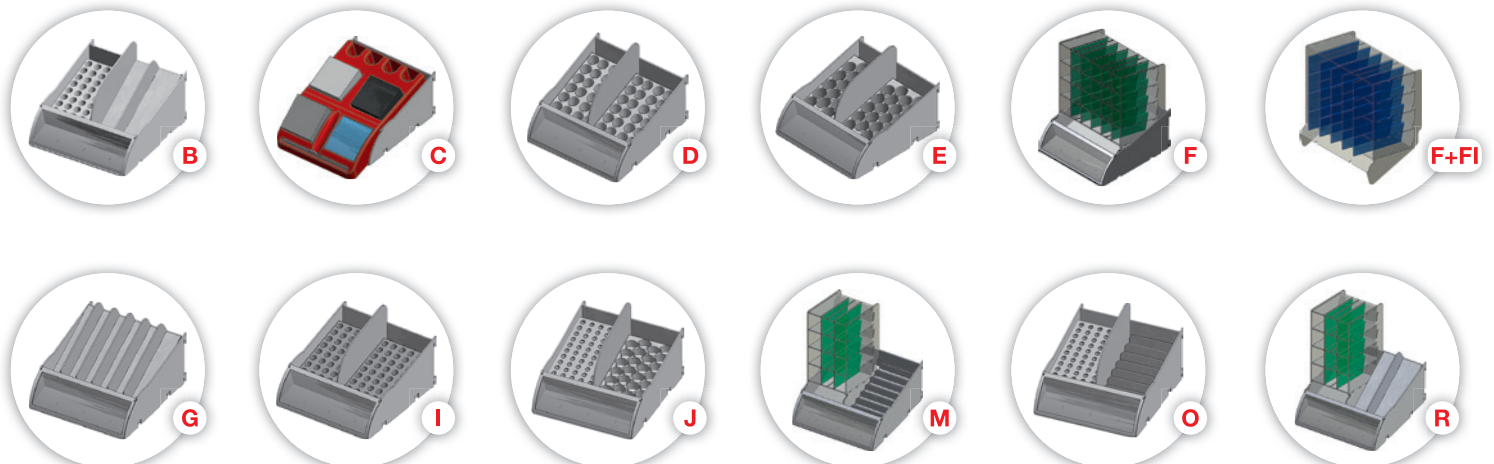

51.702 POS Shop Creative – hoch



Abbildung ähnlich



Abbildung ähnlich

Lieferumfang

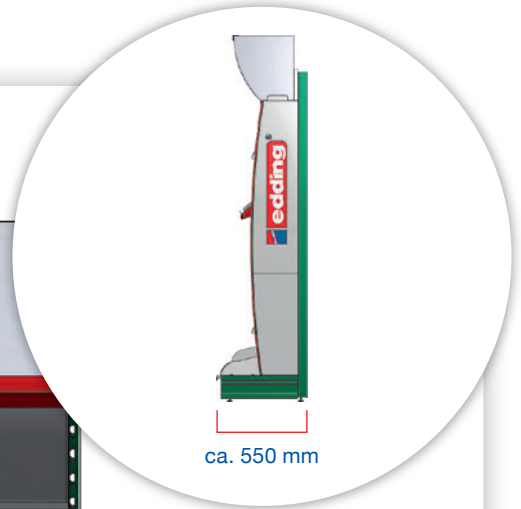
Module (= Tray + Einsätze):

■ POS Modul B 1/2	(x 1)
■ POS Modul C 16	(x 1)
■ POS Modul D 3	(x 1)
■ POS Modul E 4	(x 1)
■ POS Modul F	(x 8)
■ POS Modul F+FI	(x 2)
■ POS Modul G 5	(x 3)
■ POS Modul I 7	(x 1)
■ POS Modul M 12/13	(x 1)
■ POS Modul O 8/13	(x 1)

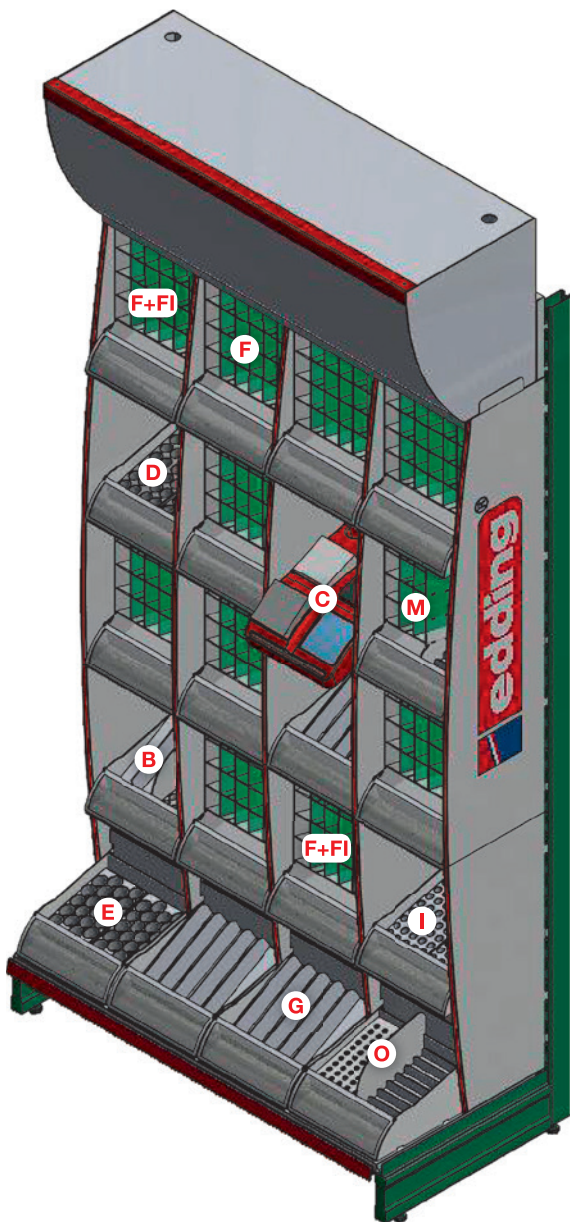
Shopteile:

■ Sockel	(x 1)
■ Rückwand	(x 4)
■ 51.754 Header	(x 1)
■ 51.756 Seitenwand hoch, rechts	(x 1)
■ 51.757 Seitenwand hoch, links	(x 1)
■ 51.777 Innenwand hoch	(x 3)
■ 51.752 Schublade hoch	(x 4)
■ Rahmenleiste unten, rot	(x 1)
■ Seitenwandhalterung zur Befestigung am Header	(x 2)

Nicht im Lieferumfang enthalten:

Tego:

- 51.779 Tego für POS Shop – hoch, 1 m breit

Verfügbare Diasätze:

- 51.791 POS Dia **DE** für DE Variante
- 51.792 POS Dia **EN** für Showroom Variante

Verfügbare Etikettensätze:

- 51.811 POS Etikettensatz **DE** für DE Variante
- 51.812 POS Etikettensatz **EN** für Showroom Variante

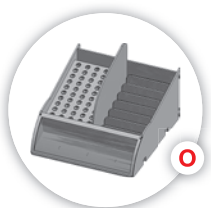
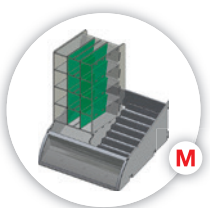
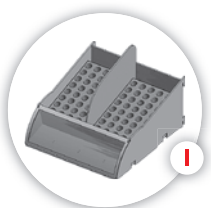
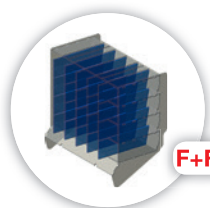
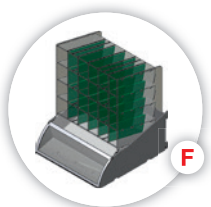
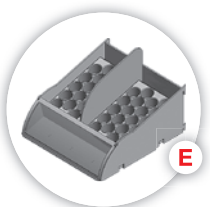
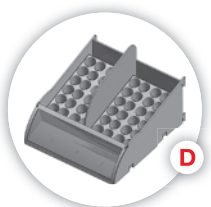
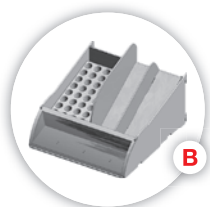

51.703 POS Shop Creative/Toys – hoch



Abbildung ähnlich



Abbildung ähnlich

Lieferumfang

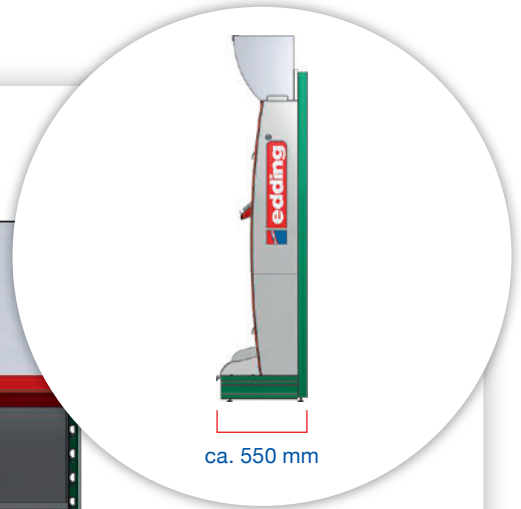
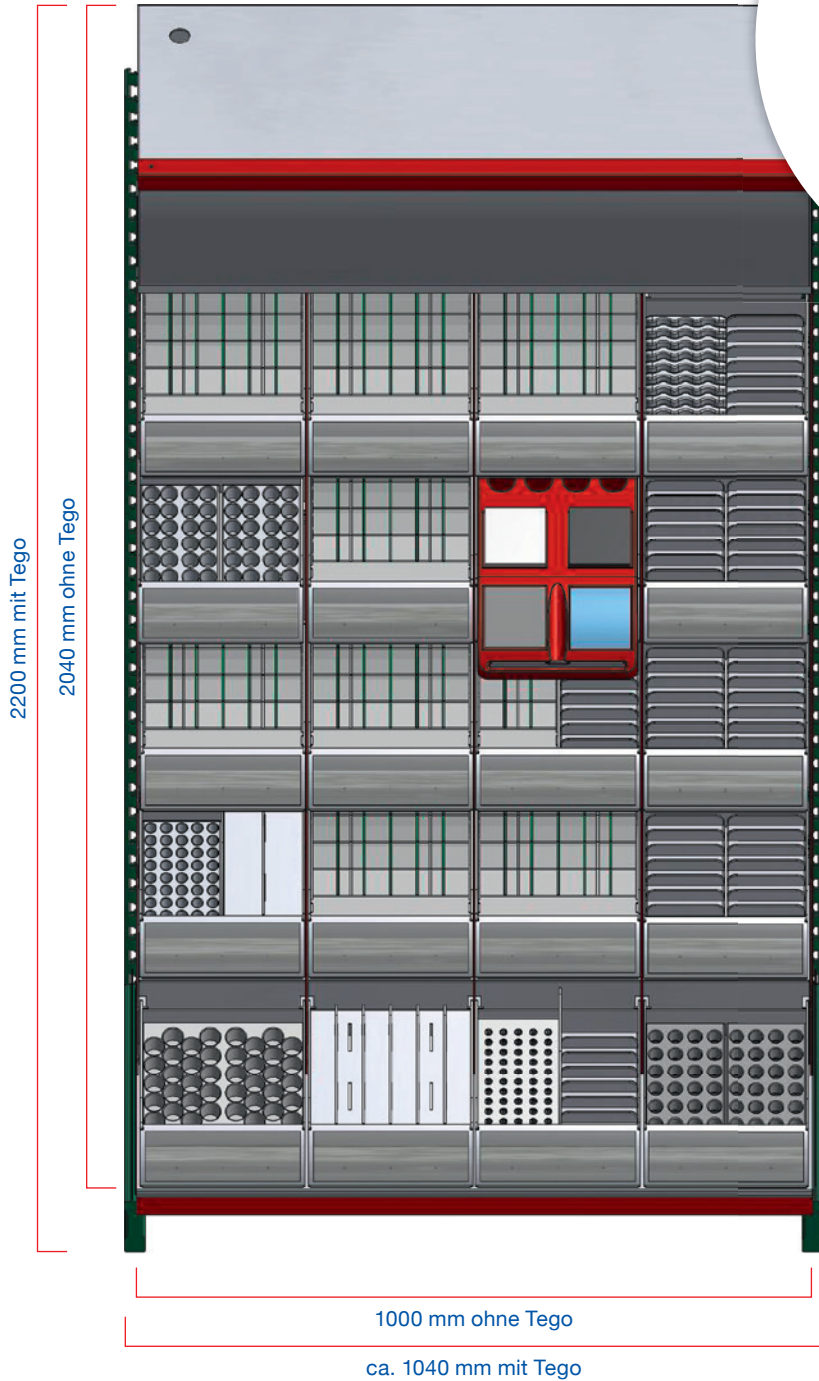
Module (= Tray + Einsätze):

■ POS Modul B 1/2	(x 1)
■ POS Modul C 16	(x 1)
■ POS Modul D 3	(x 1)
■ POS Modul E 4	(x 1)
■ POS Modul F	(x 6)
■ POS Modul F+FI	(x 2)
■ POS Modul G 5	(x 1)
■ POS Modul H 6	(x 1)
■ POS Modul M 12/13	(x 1)
■ POS Modul N 13/13	(x 3)
■ POS Modul O 8/13	(x 1)
■ POS Modul P 13/14	(x 1)

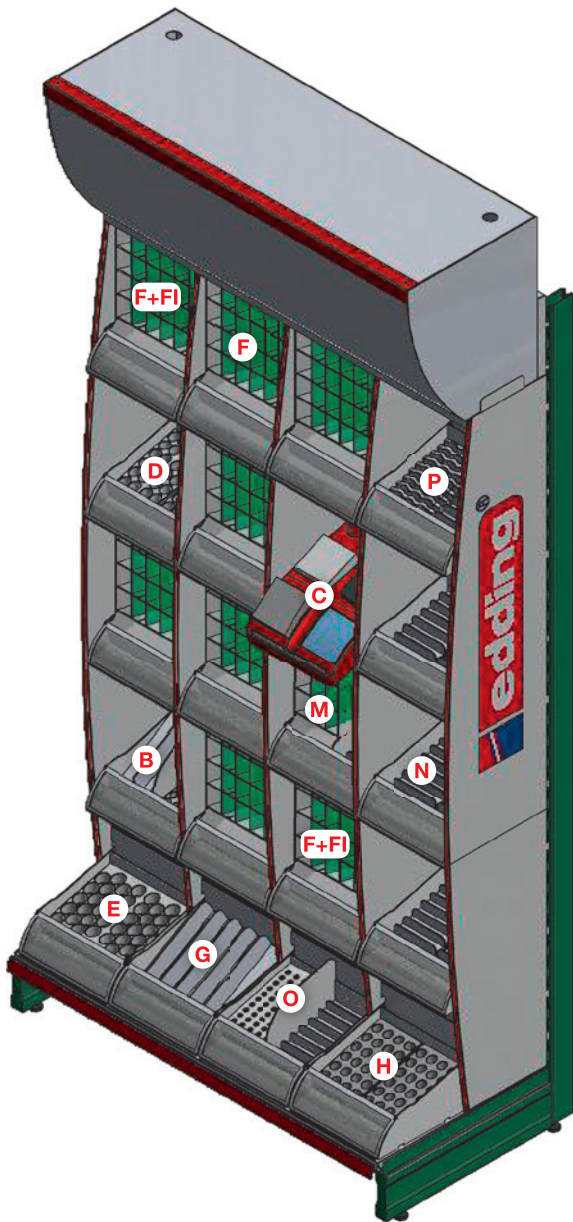
Shopteile:

■ Sockel	(x 1)
■ Rückwand	(x 4)
■ 51.754 Header	(x 1)
■ 51.756 Seitenwand hoch, rechts	(x 1)
■ 51.757 Seitenwand hoch, links	(x 1)
■ 51.777 Innenwand hoch	(x 3)
■ 51.752 Schublade hoch	(x 4)
■ Rahmenleiste unten, rot	(x 1)
■ Seitenwandhalterung zur Befestigung am Header	(x 2)

Nicht im Lieferumfang enthalten:

Tego:

- 51.779 Tego für POS Shop – hoch, 1 m breit

Verfügbare Diasätze:

- 51.793 POS Dia **DE** für DE Variante
- 51.794 POS Dia **EN** für Showroom Variante

Verfügbare Etikettensätze:

- 51.813 POS Etikettensatz **DE** für DE Variante
- 51.814 POS Etikettensatz **EN** für Showroom Variante

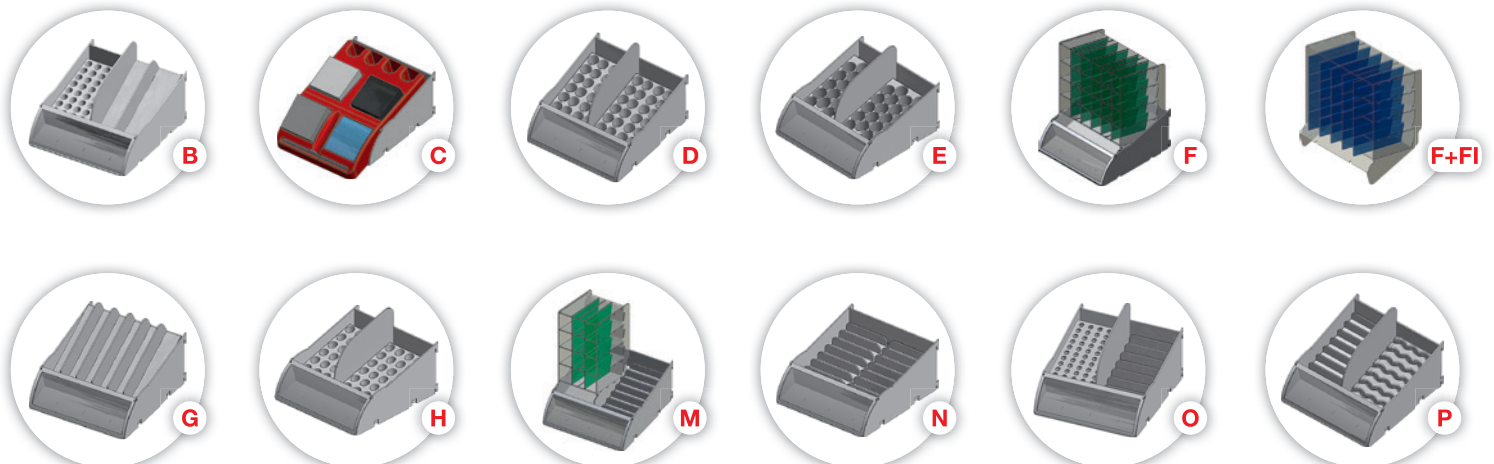

51.704 POS Shop PBS – medium



Abbildung ähnlich



Abbildung ähnlich

Lieferumfang

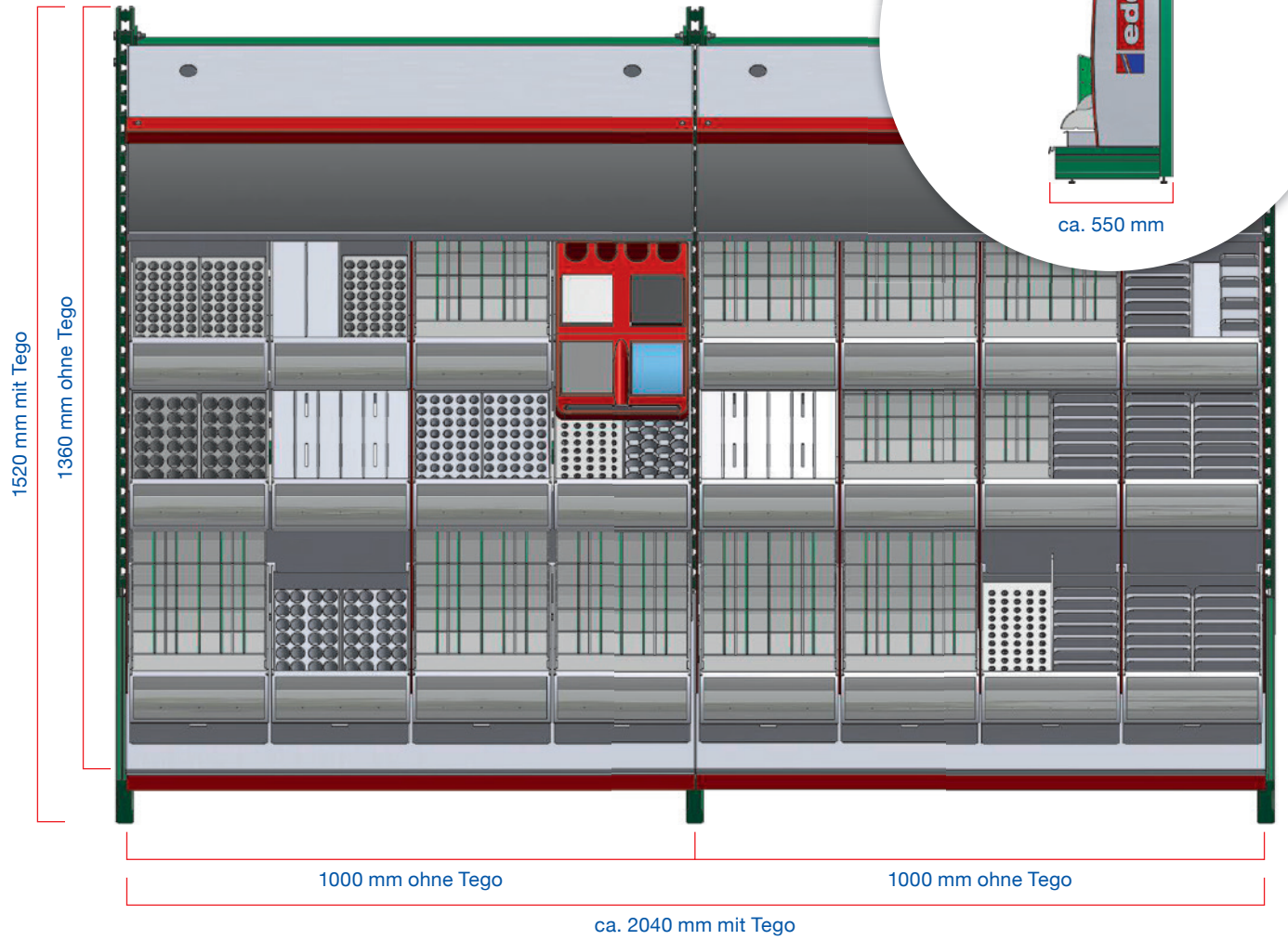
Module (= Tray + Einsätze):

■ POS Modul A 1/1	(x 1)
■ POS Modul B 2/1	(x 1)
■ POS Modul C 16	(x 1)
■ POS Modul D 3	(x 1)
■ POS Modul E 4	(x 1)
■ POS Modul F	(x 8)
■ POS Modul F+FI	(x 2)
■ POS Modul G 5	(x 2)
■ POS Modul I 7	(x 1)
■ POS Modul J 8/9	(x 1)
■ POS Modul M 12/13	(x 1)
■ POS Modul N 13/13	(x 2)
■ POS Modul O 8/13	(x 1)
■ POS Modul Q 13/15	(x 1)

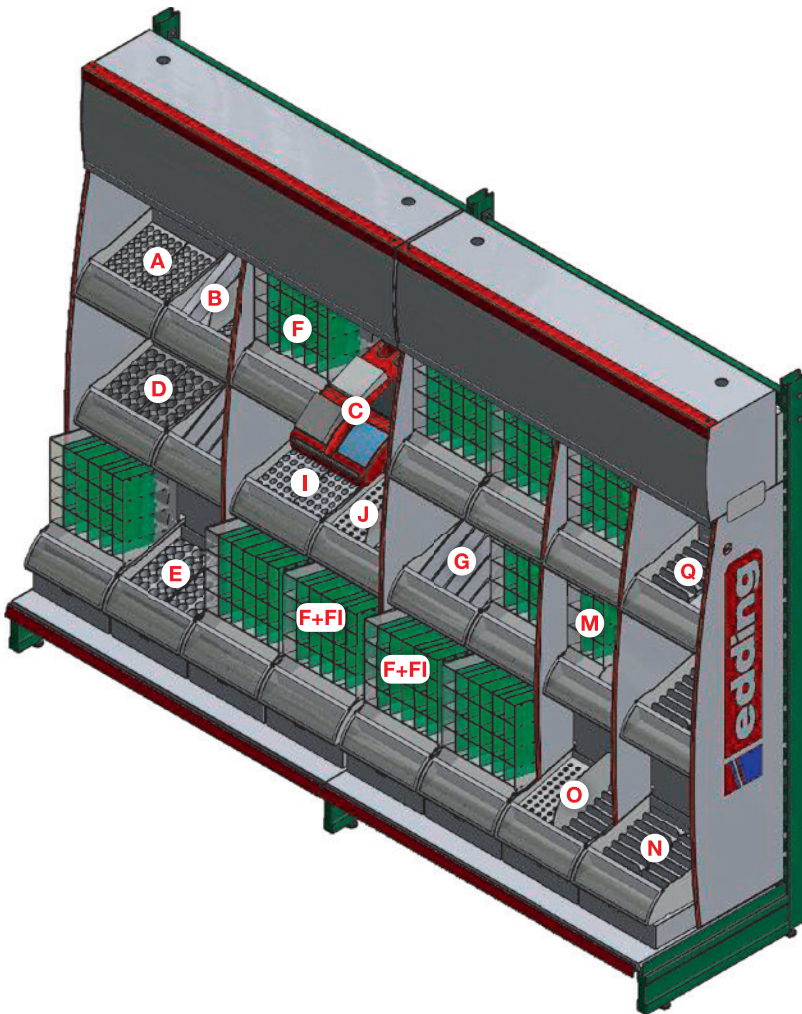
Shopteile:

■ Sockel	(x 2)
■ Rückwand	(x 4)
■ 51.755 Header	(x 2)
■ 51.758 Seitenwand medium, rechts	(x 1)
■ 51.759 Seitenwand medium, links	(x 1)
■ 51.778 Innenwand medium	(x 3)
■ 51.828 Innenwand medium, Shopmitte	(x 1)
■ 51.753 Schublade medium	(x 8)
■ Rahmenleiste unten, rot	(x 2)
■ Seitenwandhalterung zur Befestigung am Header	(x 2)
■ Verteilersteckdose, 3-fach	(x 1)

Nicht im Lieferumfang enthalten:

Tego:

- 51.781 Tego für POS Shop – medium, 2 m breit

Verfügbare Diasätze:

- 51.795 POS Dia **DE** für DE Variante
- 51.796 POS Dia **EN** für Showroom Variante

Verfügbare Etikettensätze:

- 51.815 POS Etikettensatz **DE** für DE Variante
- 51.816 POS Etikettensatz **EN** für Showroom Variante

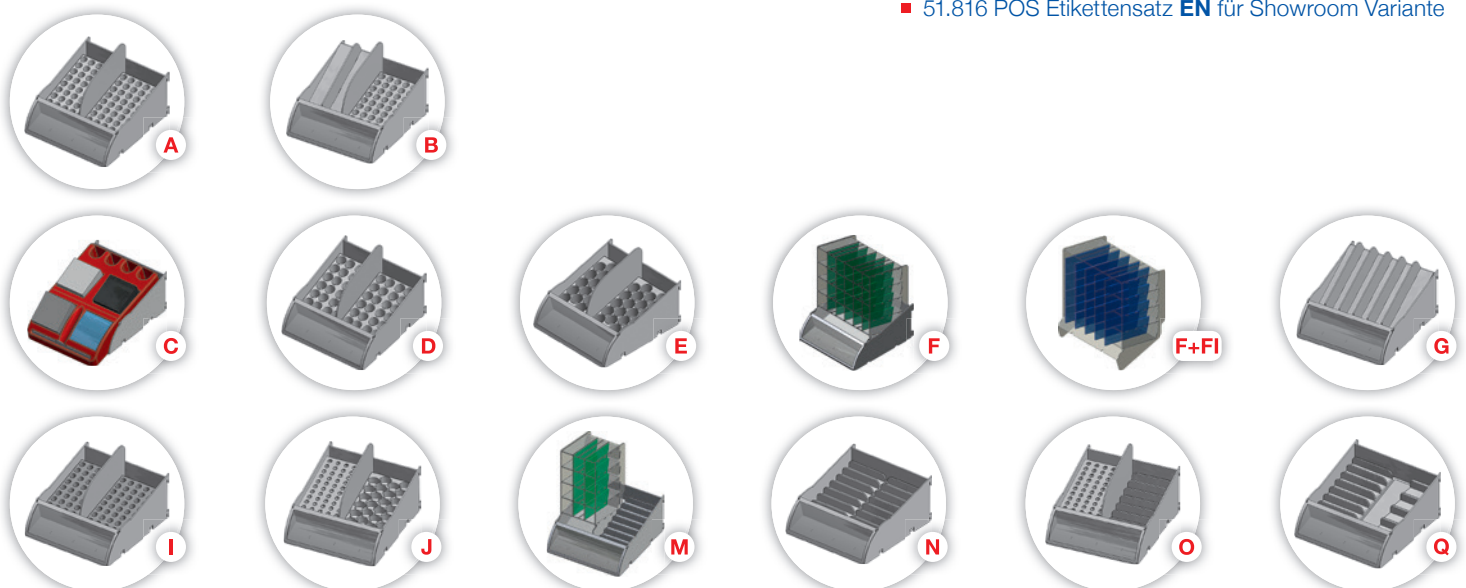

51.705 POS Shop PBS kompakt – medium



Abbildung ähnlich



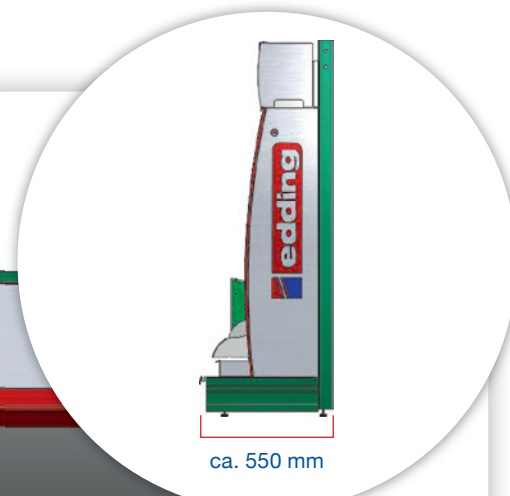
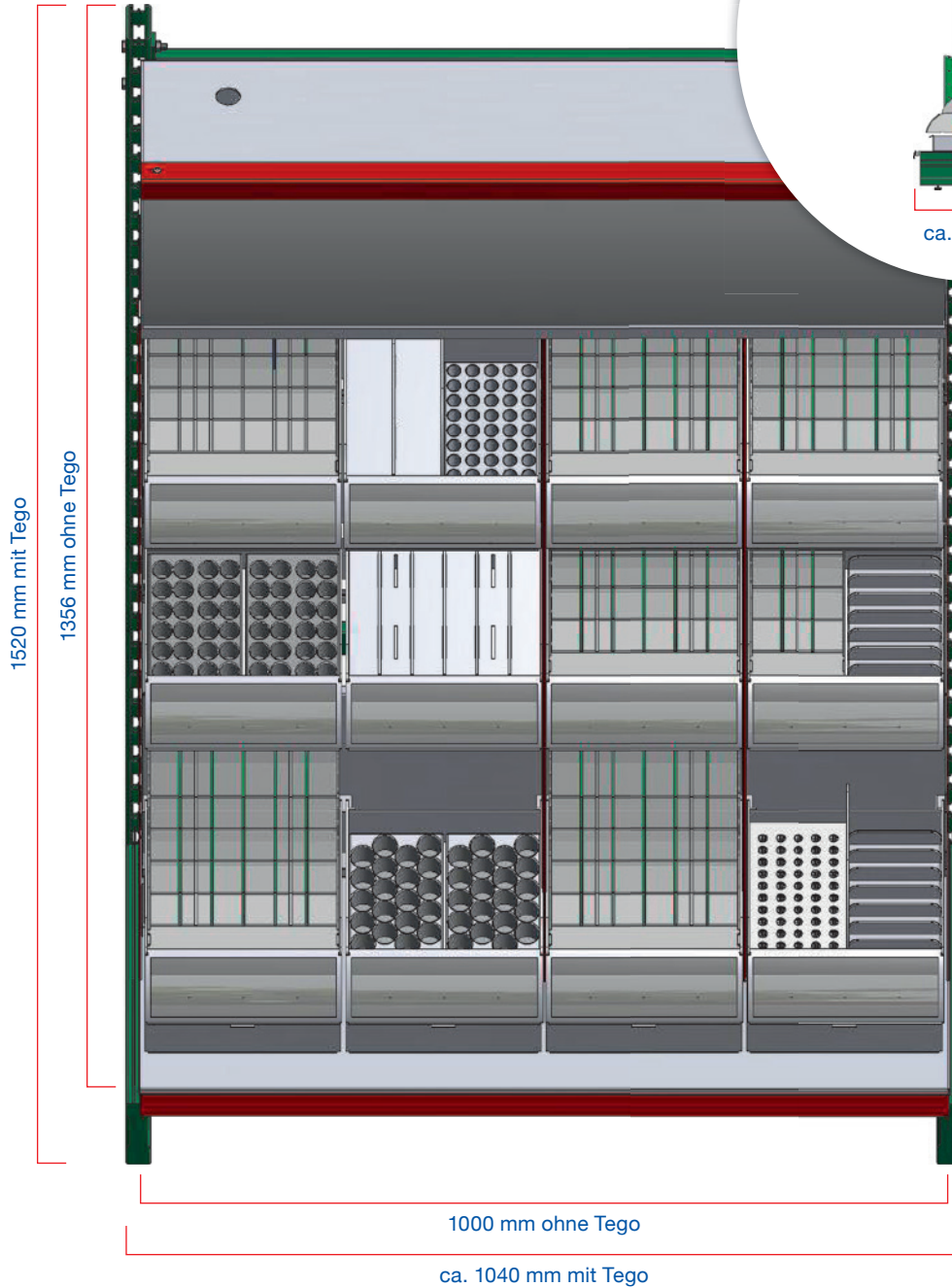

Abbildung ähnlich

Lieferumfang

Module (= Tray + Einsätze):

- POS Modul **B** 2/1 (x 1)
- POS Modul **D** 3 (x 1)
- POS Modul **E** 4 (x 1)
- POS Modul **F** (x 5)
- POS Modul **F+FI** (x 1)
- POS Modul **G** 5 (x 1)
- POS Modul **M** 12/13 (x 1)
- POS Modul **O** 8/13 (x 1)

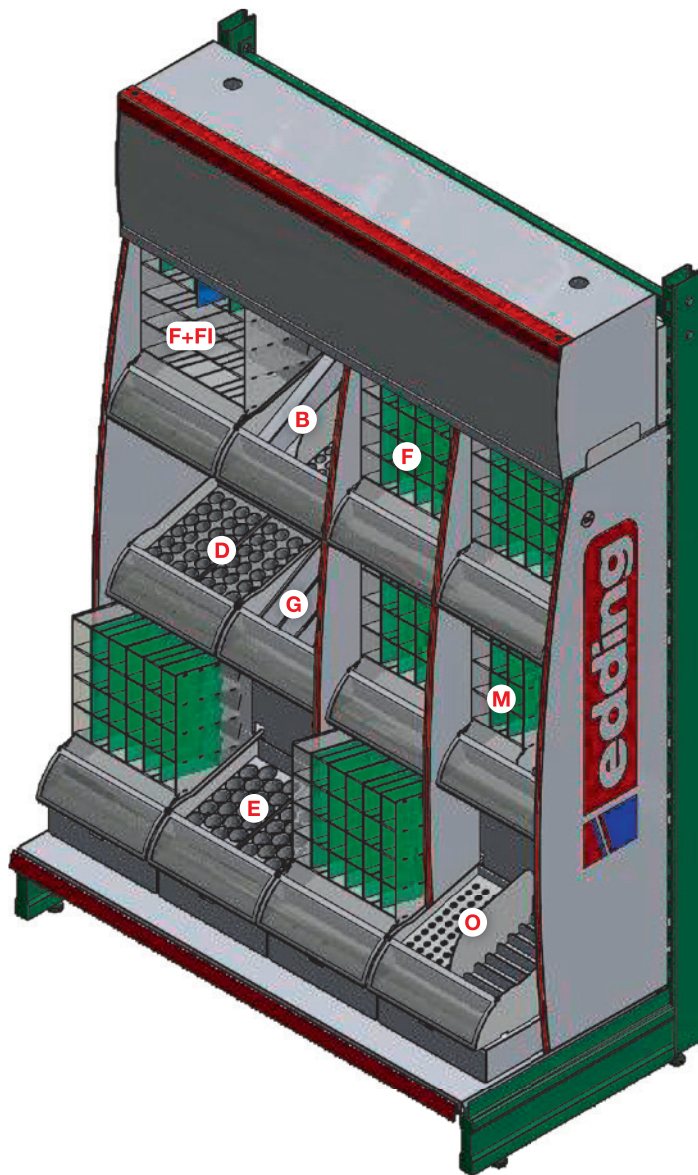
Shopteile:

- Sockel (x 1)
- Rückwand (x 2)
- 51.755 Header (x 2)
- 51.758 Seitenwand medium, rechts (x 1)
- 51.759 Seitenwand medium, links (x 1)
- 51.778 Innenwand medium (x 2)
- 51.753 Schublade medium (x 4)
- Rahmenleiste unten, rot (x 1)
- Seitenwandhalterung zur Befestigung am Header (x 2)

Nicht im Lieferumfang enthalten:

Tego:

- 51.781 Tego für POS Shop – medium, 2 m breit

Verfügbare Diasätze:

- 51.797 POS Dia **DE** für DE Variante
- 51.798 POS Dia **EN** für Showroom Variante
- 51.799 POS Dia **FR** für BeNeLux Variante
- 51.800 POS Dia **NL** für BeNeLux Variante

Verfügbare Etikettensätze:

- 51.817 POS Etikettensatz **DE** für DE Variante
- 51.818 POS Etikettensatz **EN** für Showroom Variante
- 51.819 POS Etikettensatz **FR** für BeNeLux Variante
- 51.820 POS Etikettensatz **NL** für BeNeLux Variante

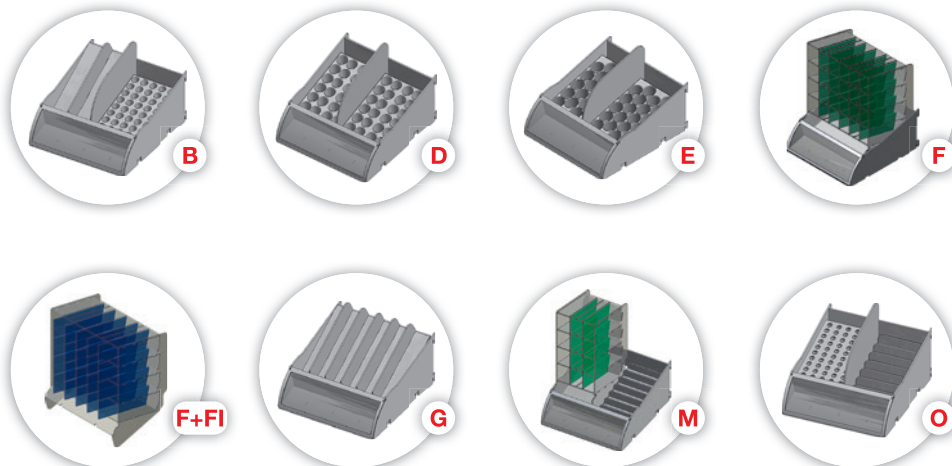

51.722 POS Shop (ES) – hoch



Abbildung ähnlich



Abbildung ähnlich

Lieferumfang

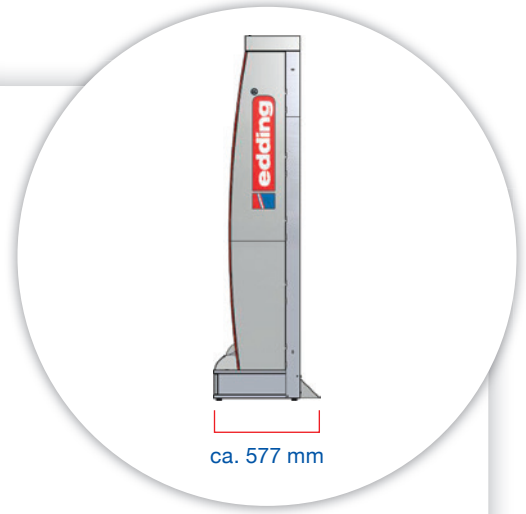
Module (= Tray + Einsätze):

■ POS Modul E 4	(x 1)
■ POS Modul F	(x 7)
■ POS Modul G 5	(x 1)
■ POS Modul N 13/3	(x 1)

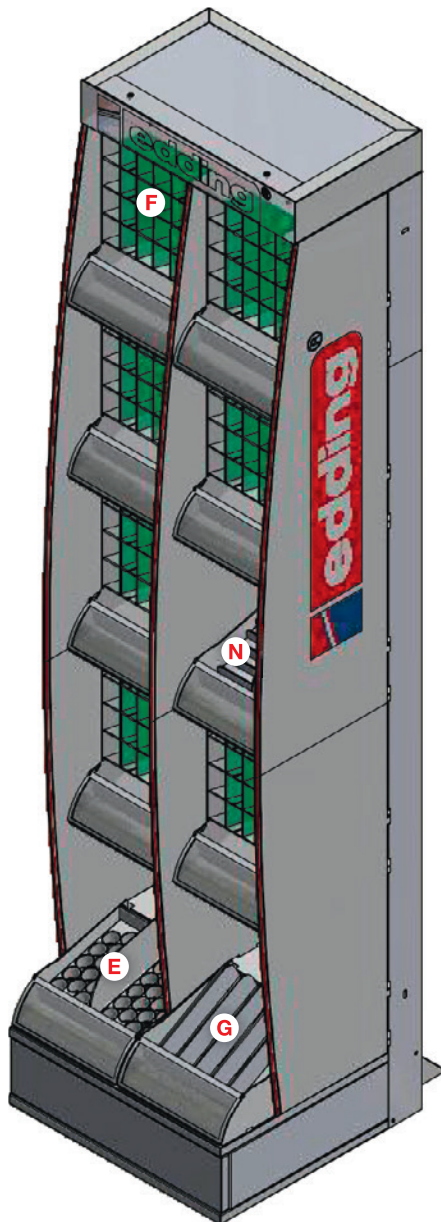
Shopteile:

■ Sockel	(x 1)
■ Rückwand 2-teilig (Metall)	(x 1)
■ 51.762 Seitenwand rechts (0,5 m)	(x 1)
■ 51.763 Seitenwand links (0,5 m)	(x 1)
■ 51.764 Innenwand (0,5 m)	(x 1)
■ Integrierter Crowner, beleuchtet	(x 1)
■ Kippschutz	(x 1)

Nicht im Lieferumfang enthalten:

- Freistehend, daher kein Tego notwendig

Verfügbare Etikettensätze:

- Noch nicht definiert

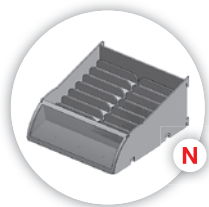
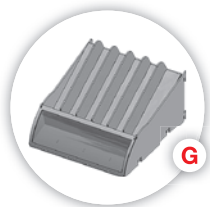
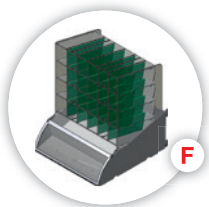
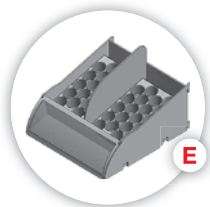

51.770 POS Shop (CEE) – hoch



Abbildung ähnlich



Abbildung ähnlich

Lieferumfang

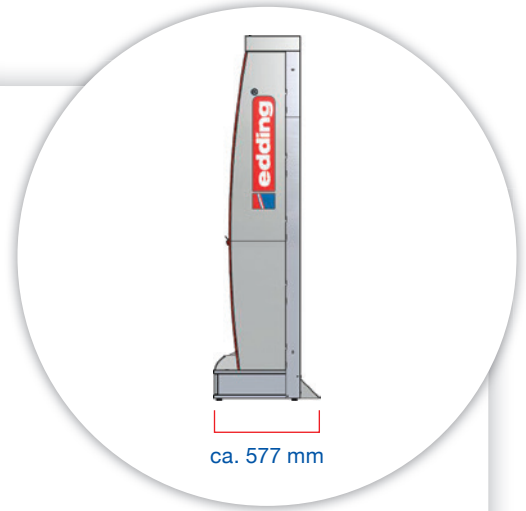
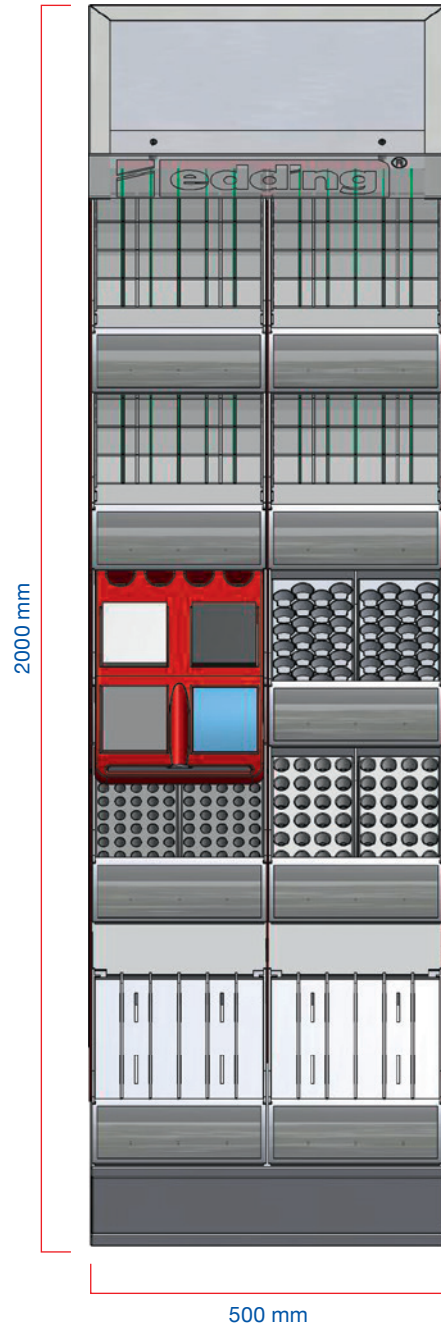
Module (= Tray + Einsätze):

■ POS Modul C 16	(x 1)
■ POS Modul F	(x 4)
■ POS Modul G 5	(x 2)
■ POS Modul H 6	(x 1)
■ POS Modul I 7	(x 1)
■ POS Modul V 9/9	(x 1)

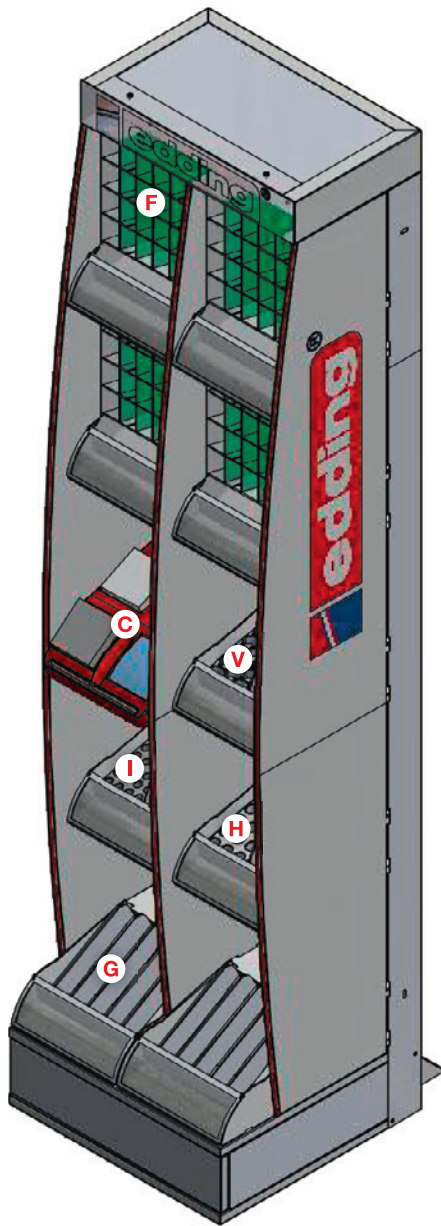
Shopteile:

■ Sockel	(x 1)
■ Rückwand 2-teilig (Metall)	(x 1)
■ 51.762 Seitenwand rechts (0,5 m)	(x 1)
■ 51.763 Seitenwand links (0,5 m)	(x 1)
■ 51.764 Innenwand (0,5 m)	(x 1)
■ Integrierter Crouner, beleuchtet	(x 1)
■ Kippschutz	(x 1)

Nicht im Lieferumfang enthalten:

- Freistehend, daher kein Tego notwendig





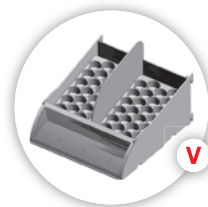
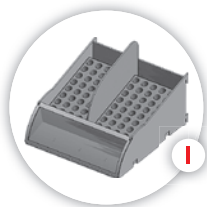
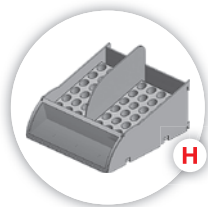
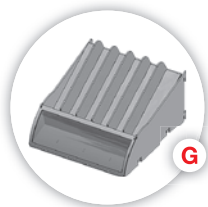
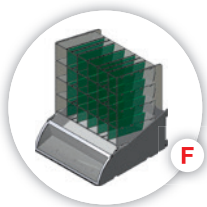
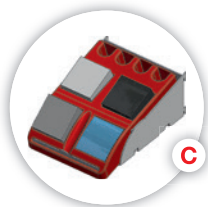





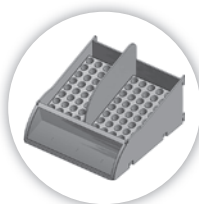

Verfügbare Etikettensätze:





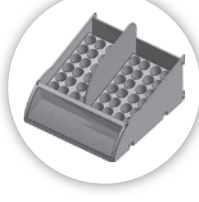
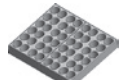

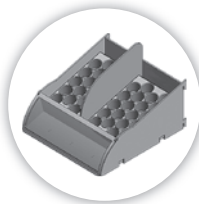
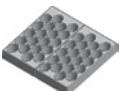



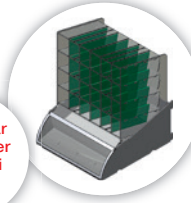



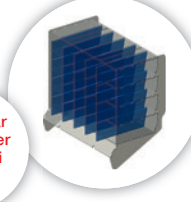

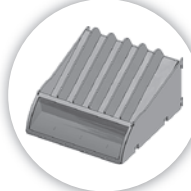
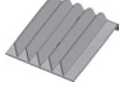
- Noch nicht definiert

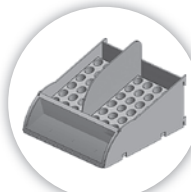

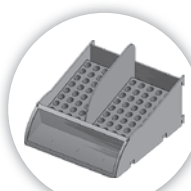







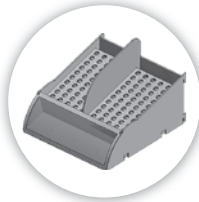





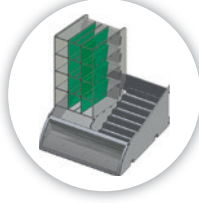



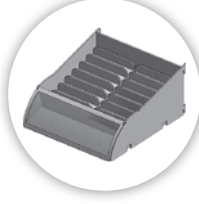





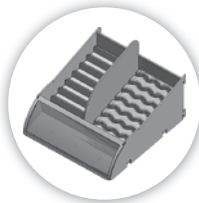





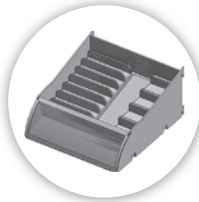



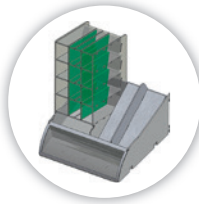



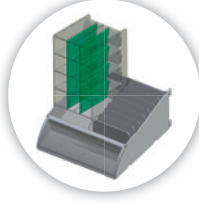

Module (= Tray + Einsätze)

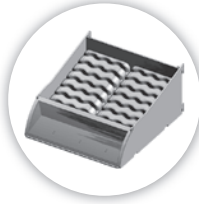
Der folgenden Gesamtliste aller Module können Sie entnehmen, welche Einsatzteile jeweils in einem Modul verwendet werden und für welche Produkte diese geeignet sind.

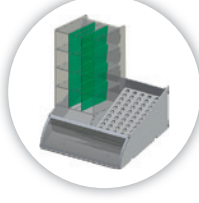
Module	Einsatzteile	Anzahl pro Modul	geeignet für Schaftform (Anzahl)
A 1/1 	51.706 Einsatz 1 Art.-Nr. 4-51706 	2x	e-400 (je Einsatz x 40)
	51.768 Trennsteg Art.-Nr. 4-51768 	1x	
B 2/1 	51.707 Einsatz 2 Art.-Nr. 4-51707 	1x	universal
	51.706 Einsatz 1 Art.-Nr. 4-51706 	1x	e-400 (x 40)
	51.768 Trennsteg Art.-Nr. 4-51768 	1x	
C 16 	51.721 Einsatz 16 Art.-Nr. 4-51721 	1x	
D 3 	51.708 Einsatz 3 Art.-Nr. 4-51708 	1x	e-500 (x 48)
	51.768 Trennsteg Art.-Nr. 4-51768 	1x	
E 4 	51.709 Einsatz 4 Art.-Nr. 4-51709 	1x	e-800 (x 40)
	51.768 Trennsteg Art.-Nr. 4-51768 	1x	

Module	Einsatzteile	Anzahl pro Modul	geeignet für Schaftform (Anzahl)
<p>F</p>  <p>Nicht einsetzbar in unterster Reihe bei 2,04 m Shops</p>	<p>■ Tray + Köchereinsatz Art.-Nr. 4-51727</p>		<p>■ universal</p>
	<p>■ 51.743 Trenner-Set, kurz </p>	1x 20er Set	<p>■ max. 24 Fächer</p>
	<p>■ 51.783 Fachverkürzer </p>	1x 25er Set	<p>■ reduziert die Fachtiefe für Produkte mit kürzerem Schaft (z. B. bei e-3000)</p>
	<p>■ 51.744 Trenner, groß, weiß </p>	1x	<p>■ zur optischen Trennung in der Modulmitte beim Einsatz von 2 unterschiedlichen Produkten (z. B. e-1200/e-1300)</p>
<p>F+FI</p>  <p>Nicht einsetzbar in unterster Reihe bei 2,04 m Shops</p> <p>Bei Bestellung Modul-Namen angeben!</p>	<p>■ Tray + Köchereinsatz Art.-Nr. 4-51727</p>		<p>■ universal</p>
	<p>■ 51.741 Trenner-Set, FI lang inkl. Etikettensatz „Strichstärke“ </p>	1x 20er Set	<p>■ für das Kennzeichnen von unterschiedlichen Strichstärken wie e-1255/e-1800</p>
	<p>■ 51.783 Fachverkürzer </p>	1x 25er Set	<p>■ reduziert die Fachtiefe für Produkte mit kürzerem Schaft (z. B. bei e-3000)</p>
<p>G 5</p> 	<p>■ 51.710 Einsatz 5 Art.-Nr. 4-51710 </p>	1x	<p>■ universal</p>
	<p>■ 51.742 Trennsteg-Set Art.-Nr. 4-51742 </p>	1x 5er Set	
<p>H 6</p> 	<p>■ 51.711 Einsatz 6 Art.-Nr. 4-51711 </p>	1x	<p>■ e-380 (x 48)</p>
	<p>■ 51.768 Trennsteg Art.-Nr. 4-51768 </p>	1x	
<p>I 7</p> 	<p>■ 51.712 Einsatz 7 Art.-Nr. 4-51712 </p>	1x	<p>■ e-140 (x 80)</p>
	<p>■ 51.768 Trennsteg Art.-Nr. 4-51768 </p>	1x	
<p>J 8/9</p> 	<p>■ 51.713 Einsatz 8 Art.-Nr. 4-51713 </p>	1x	<p>■ e-66/e-2185 (x 50)</p>
	<p>■ 51.714 Einsatz 9 Art.-Nr. 4-51714 </p>	1x	<p>■ e-24/e-345 (x 24)</p>
	<p>■ 51.768 Trennsteg Art.-Nr. 4-51768 </p>	1x	

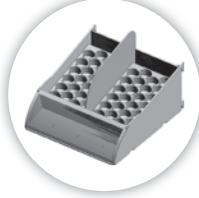
Module	Einsatzteile	Anzahl pro Modul	geeignet für Schaffform (Anzahl)
K 8/8 	51.713 Einsatz 8 Art.-Nr. 4-51713 	2x	e-66/e-2185 (je Einsatz x 50)
	51.768 Trennsteg Art.-Nr. 4-51768 	1x	
L 10/11 	51.715 Einsatz 10 Art.-Nr. 4-51715 	1x	e-R10 (x 7) + e-R20 (x 14)
	51.716 Einsatz 11 Art.-Nr. 4-51716 	1x	e-7700 (x 35)
	51.768 Trennsteg Art.-Nr. 4-51768 	1x	
M 12/13 	51.717 Einsatz 12 Art.-Nr. 4-51717 	1x	universal
	51.718 Einsatz 13 Art.-Nr. 4-51718 	1x	Sets (x 7)
	51.750 Trenner-Set, kurz 	1x 8er Set	max. 12 Fächer
	51.783 Fachverkürzer 	1x 25er Set	reduziert die Fachtiefe für Produkte mit kürzerem Schaft (z. B. bei e-3000)
N 13/13 	51.718 Einsatz 13 Art.-Nr. 4-51718 	2x	Sets (je Einsatz x 7)
	51.768 Trennsteg Art.-Nr. 4-51768 	1x	
O 8/13 	51.713 Einsatz 8 Art.-Nr. 4-51713 	1x	e-66/e-2185 (x 50)
	51.718 Einsatz 13 Art.-Nr. 4-51718 	1x	Sets (x 7)
	51.768 Trennsteg Art.-Nr. 4-51768 	1x	
P 13/14 	51.718 Einsatz 13 Art.-Nr. 4-51718 	1x	Sets (x 7)
	51.719 Einsatz 14 Art.-Nr. 4-51719 	1x	Blister (x 7)
	51.768 Trennsteg Art.-Nr. 4-51768 	1x	









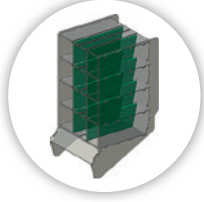

Module	Einsatzteile	Anzahl pro Modul	geeignet für Schaftform (Anzahl)
■ Q 13/15 	■ 51.718 Einsatz 13 Art.-Nr. 4-51718 	1x	■ Sets (x 7)
	■ 51.720 Einsatz 15 Art.-Nr. 4-51720 	1x	■ e-15 18er Set (x 4)
	■ 51.768 Trennsteg Art.-Nr. 4-51768 	1x	
■ R 12/2 	■ 51.717 Einsatz 12 Art.-Nr. 4-51717 	1x	■ universal
	■ 51.707 Einsatz 2 Art.-Nr. 4-51707 	1x	■ universal
	■ 51.750 Trenner-Set, kurz 	1x 8er Set	■ max. 12 Fächer
	■ 51.783 Fachverkürzer 	1x 25er Set	■ reduziert die Fachtiefe für Produkte mit kürzerem Schaft (z. B. bei e-3000)
■ S 12/17 	■ 51.717 Einsatz 12 Art.-Nr. 4-51717 	1x	■ universal
	■ 51.747 Einsatz 17 Art.-Nr. 4-51747 	1x	■ Sets e-400/e-3000
	■ 51.750 Trenner-Set, kurz 	1x 8er Set	■ max. 12 Fächer
	■ 51.783 Fachverkürzer 	1x 25er Set	■ reduziert die Fachtiefe für Produkte mit kürzerem Schaft (z. B. bei e-3000)
■ T 14/14 	■ 51.719 Einsatz 14 Art.-Nr. 4-51719 	2x	■ Blister je Einsatz (x 7)
	■ 51.768 Trennsteg Art.-Nr. 4-51768 	1x	
■ U 12/8 	■ 51.717 Einsatz 12 Art.-Nr. 4-51717 	1x	■ universal
	■ 51.713 Einsatz 8 Art.-Nr. 4-51713 	1x	■ e-66/e-2185 (x 50)
	■ 51.750 Trenner-Set, kurz 	1x 8er Set	■ max. 12 Fächer
	■ 51.783 Fachverkürzer 	1x 25er Set	■ reduziert die Fachtiefe für Produkte mit kürzerem Schaft (z. B. bei e-3000)
■ V 9/9 	■ 51.714 Einsatz 9 Art.-Nr. 4-51714 	2x	■ e-24/e-345 (je Einsatz x 24)
	■ 51.768 Trennsteg Art.-Nr. 4-51768 	1x	

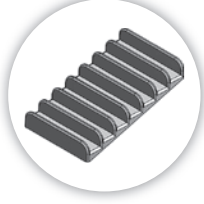
Einzelteile

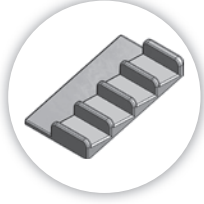

Nachfolgend finden Sie alle Einzelteile aufgelistet, aus denen sich die Module und Shops zusammensetzen. Die nachfolgenden Tabellen beinhalten zum einen die Dias für die Header, auf denen die Produktanwendungsbereiche abgebildet sind, und zum anderen die Etikettensätze zur Beschreibung der jeweiligen Produkte. Beides muss zum jeweiligen Shop mitbestellt werden!

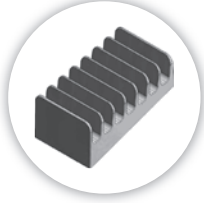
Einsätze	Hinweis	EAN
<p>■ 51.706 Einsatz 1 Art.-Nr. 4-51706</p> 	<p>■ e-400 (x 40)</p>	 4 004764 961153
<p>■ 51.707 Einsatz 2 Art.-Nr. 4-51707</p> 	<p>■ universal</p>	 4 004764 961160
<p>■ 51.708 Einsatz 3 Art.-Nr. 4-51708</p> 	<p>■ e-500 (x 48)</p>	 4 004764 961177
<p>■ 51.709 Einsatz 4 Art.-Nr. 4-51709</p> 	<p>■ e-800 (x 40)</p>	 4 004764 961184
<p>■ 51.710 Einsatz 5 Art.-Nr. 4-51710</p> 	<p>■ universal ■ variable Facheinteilung: 2, 3, 4 oder 6 gleiche Fächer</p>	 4 004764 961191

Einsätze	Hinweis	EAN
<p>■ 51.711 Einsatz 6 Art.-Nr. 4-51711</p> 	<p>■ e-380 (x 48)</p>	 4 004764 961207
<p>■ 51.712 Einsatz 7 Art.-Nr. 4-51712</p> 	<p>■ e-140 (x 80)</p>	 4 004764 961214
<p>■ 51.713 Einsatz 8 Art.-Nr. 4-51713</p> 	<p>■ e-66/e-2185 (x 50)</p>	 4 004764 961221
<p>■ 51.714 Einsatz 9 Art.-Nr. 4-51714</p> 	<p>■ e-24/e-345 (x 24)</p>	 4 004764 961238
<p>■ 51.715 Einsatz 10 Art.-Nr. 4-51715</p> 	<p>■ e-R10 (x 7) + e-R20 (x 14)</p>	 4 004764 961245
<p>■ 51.716 Einsatz 11 Art.-Nr. 4-51716</p> 	<p>■ e-7700 (x 35)</p>	 4 004764 961252

Einsätze	Hinweis	EAN
<p>■ 51.717 Einsatz 12 Art.-Nr. 4-51717</p> 	<ul style="list-style-type: none"> ■ universal ■ inkl. 8 Trennstege (Fachteiler), kurz 	 4 004764 961269
<p>■ 51.718 Einsatz 13 Art.-Nr. 4-51718</p> 	<ul style="list-style-type: none"> ■ Sets (x 7) 	 4 004764 961276
<p>■ 51.719 Einsatz 14 Art.-Nr. 4-51719</p> 	<ul style="list-style-type: none"> ■ Blister (x 7) 	 4 004764 961283
<p>■ 51.720 Einsatz 15 Art.-Nr. 4-51720</p> 	<ul style="list-style-type: none"> ■ Sets (x 7) + e-15 18er Set (x 4) 	 4 004764 961320
<p>■ 51.721 Einsatz 16 Art.-Nr. 4-51721</p> 	<ul style="list-style-type: none"> ■ Testblöcke separat nachbestellbar 	 4 004764 961337
<p>■ 51.747 Einsatz 17 Art.-Nr. 4-51747</p> 	<ul style="list-style-type: none"> ■ Sets e-400/e-3000 	 4 004764 961993

Module	Hinweis	EAN
<p>■ Modul F Art.-Nr. 4-51727</p>  <p>Bei Bestellung Modul-Namen angeben!</p>	<ul style="list-style-type: none"> ■ universal ■ inkl. 25 Fachverkürzer ■ inkl. 20 Trennstege (Fachteiler), kurz ■ inkl. Trenner, groß, weiß ■ Nicht einsetzbar in unterster Reihe bei 2,04 m Shops 	 <p>4 1004764 961801</p>
<p>■ Modul F+FI Art.-Nr. 4-51727</p> 	<ul style="list-style-type: none"> ■ universal ■ inkl. 25 Fachverkürzer ■ inkl. 20 Trennstege (Fachteiler), FI lang inkl. Etikettensatz „Strichstärke“ ■ Nicht einsetzbar in unterster Reihe bei 2,04 m Shops 	 <p>4 1004764 961801</p>
Zubehör Module	Hinweis	EAN
<p>■ 51.741 Trenner-Set, FI lang Art.-Nr. 4-51741</p> 	<ul style="list-style-type: none"> ■ langer Fachteiler für Köcher inkl. Etikettensatz „Strichstärke“ ■ Standard Fachteiler für Modul F+FI ■ Set = 20 Stück 	 <p>4 1004764 961931</p>
<p>■ 51.801 Trenner-Set, FI lang Art.-Nr. 4-51801</p> 	<ul style="list-style-type: none"> ■ langer Fachteiler für halben Köcher (Einsatz 51.717) inkl. Etikettensatz „Strichstärke“ ■ Set = 8 Stück 	 <p>4 1004764 963270</p>
<p>■ 51.742 Trennsteg-Set, weiß Art.-Nr. 4-51742</p> 	<ul style="list-style-type: none"> ■ Set = 5 Stück 	 <p>4 1004764 961948</p>

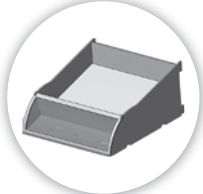







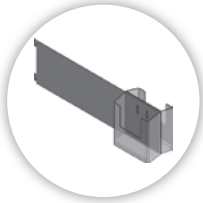

Zubehör Module	Hinweis	EAN
<p>■ 51.743 Trenner-Set, kurz Art.-Nr. 4-51743</p> 	<ul style="list-style-type: none"> ■ Standard-Fachteiler für Modul F ■ Set = 20 Stück 	 4 1004764 961955 1
<p>■ 51.750 Trenner-Set, kurz Art.-Nr. 4-51750</p> 	<ul style="list-style-type: none"> ■ kurzer Fachteiler für halben Köcher (Einsatz 51.717) ■ Set = 8 Stück 	 4 1004764 962020 1
<p>■ 51.744 Trenner, groß, weiß Art.-Nr. 4-51744</p> 	<ul style="list-style-type: none"> ■ Kamm für Modul F ■ zur optischen Trennung in der Modulmitte beim Einsatz von 2 unterschiedlichen Produkten (z. B. e-1200/e-1300) 	 4 1004764 961962 1
<p>■ 51.783 Fachverkürzer, Karton Art.-Nr. 4-51783</p> 	<ul style="list-style-type: none"> ■ reduziert die Fachtiefe für Produkte mit kürzerem Schaft (z. B. bei e-3000) ■ Set = 25 Stück 	 4 1004764 963072 1
<p>■ 51.768 Trennsteg Art.-Nr. 4-51768</p> 	<ul style="list-style-type: none"> ■ zur optischen Trennung in der Modulmitte beim Einsatz von 2 unterschiedlichen Produkten (z. B. e-1200/e-1300) 	 4 1004764 962204 1
<p>■ 51.751 Tray mit Beleuchtung Art.-Nr. 4-51751</p> 	<ul style="list-style-type: none"> ■ Leertray mit Klappe ■ LED-Beleuchtung ■ geeignet für Module oberhalb der untersten Modul-Reihe ■ nicht für 0,5 m Shop geeignet 	 4 1004764 962037 1

Zubehör Module	Hinweis	EAN
<p>■ 51.776 Tray ohne Beleuchtung Art.-Nr. 4-51776</p> 	<ul style="list-style-type: none"> ■ Leertray mit Klappe ■ ausschließlich zur Verwendung in der untersten Reihe ■ Standard-Modul in 0,5 m Shops 	 4 1004764 962808
<p>■ 51.745 Trayklappe Art.-Nr. 4-51745</p> 	<ul style="list-style-type: none"> ■ Klappe mit integriertem Sichtfenster für Etiketten 	 4 1004764 961979
<p>■ 51.775 Scheibe für Einsatz 51.721 Art.-Nr. 4-51775</p> 	<ul style="list-style-type: none"> ■ Sichtfenster „HIER TESTEN JETZT NEU“ 	 4 1004764 962792
<p>■ 51.784 Verbindungsklammer Tray Art.-Nr. 4-51784</p> 	<ul style="list-style-type: none"> ■ Clip-Verbinder für seitliche Verbindung der Trays untereinander ■ Set = 4 Stück ■ in POS Shops nicht notwendig 	 4 1004764 963089
<p>■ 51.746 Testblock Folie Art.-Nr. 4-51746</p> 	<ul style="list-style-type: none"> ■ Folie, VE = 6 Stück 	 4 1004764 961986
<p>■ 51.825 Testblock weiß Art.-Nr. 4-51825</p> 	<ul style="list-style-type: none"> ■ weißes Papier, VE = 6 Stück 	 4 1004764 963799

Zubehör Module	Hinweis	EAN
<p>■ 51.826 Testblock schwarz Art.-Nr. 4-51826</p> 	<p>■ schwarzes Papier, VE = 6 Stück</p>	 4 1004764 963812
<p>■ 51.803 Etikettensatz Strichstärken Art.-Nr. 4-51803</p> 	<p>■ zum Bekleben der langen Fachteiler (Trennstege), FI lang, zum Kennzeichnen der Strichstärken</p> <p>■ Set = 2 Etikettenbögen A4</p>	 4 1004764 963294
<p>Shop-Einzelteile</p>	<p>Hinweis</p>	<p>EAN</p>
<p>■ 51.754 Header hoch Art.-Nr. 4-51754</p> 	<p>■ für 2,04 m Shops</p>	 4 1004764 962068
<p>■ 51.755 Header medium Art.-Nr. 4-51755</p> 	<p>■ für 1,36 m Shops</p>	 4 1004764 962075
<p>■ 51.756 Seitenwand hoch, rechts Art.-Nr. 4-51756</p> 	<p>■ für 2,04 m Shops</p>	 4 1004764 962082

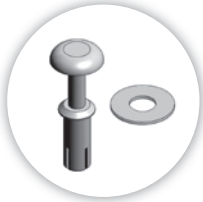
Shop-Einzelteile	Hinweis	EAN
<p>■ 51.757 Seitenwand hoch, links Art.-Nr. 4-51757</p> 	<p>■ für 2,04 m Shops</p>	 4 004764 962099
<p>■ 51.758 Seitenwand medium, rechts Art.-Nr. 4-51758</p> 	<p>■ für 1,36 m Shops</p>	 4 004764 962105
<p>■ 51.759 Seitenwand medium, links Art.-Nr. 4-51759</p> 	<p>■ für 1,36 m Shops</p>	 4 004764 962112
<p>■ 51.762 Seitenwand rechts (0,5 m) Art.-Nr. 4-51762</p> 	<p>■ für 0,5 m Shops</p>	 4 004764 962143
<p>■ 51.763 Seitenwand links (0,5 m) Art.-Nr. 4-51763</p> 	<p>■ für 0,5 m Shops</p>	 4 004764 962150
<p>■ 51.777 Innenwand hoch Art.-Nr. 4-51777</p> 	<p>■ für 2,04 m Shops ■ Kategorietrenner</p>	 4 004764 962815

Shop-Einzelteile	Hinweis	EAN
<p>■ 51.827 Innenwand hoch, Shopmitte Art.-Nr. 4-51827</p> 	<p>■ für 2 x 2,04 m Shops ■ Kategorietrenner</p>	 4 004764 964840
<p>■ 51.778 Innenwand medium Art.-Nr. 4-51778</p> 	<p>■ für 1,36 m Shops ■ Kategorietrenner</p>	 4 004764 962822
<p>■ 51.828 Innenwand medium, Shopmitte Art.-Nr. 4-51828</p> 	<p>■ für 2 x 1,36 m Shops ■ Kategorietrenner</p>	 4 004764 964857
<p>■ 51.764 Innenwand (0,5 m) Art.-Nr. 51764</p> 	<p>■ für 0,5 m Shops</p>	 4 004764 962167
<p>■ 51.752 Schublade hoch Art.-Nr. 4-51752</p> 	<p>■ für 2,04 m Shops</p>	 4 004764 962044
<p>■ 51.753 Schublade medium Art.-Nr. 4-51753</p> 	<p>■ für 1,36 m Shops</p>	 4 004764 962051

Shop-Einzelteile	Hinweis	EAN
<p>■ 51.749 Prospekthalter Art.-Nr. 4-51749</p> 	<ul style="list-style-type: none"> ■ nicht im Lieferumfang der Shops enthalten ■ Aktion mit Prospekthalter erst zu späterem Zeitpunkt geplant ■ nicht für 0,5 m Shop geeignet 	 <p>4 004764 962013</p>
<p>■ 51.765 LED Set Module Art.-Nr. 4-51765</p> 	<ul style="list-style-type: none"> ■ 4 Ersatz-LED-Schienen für Module ■ Verwendung ausschließlich in Modulen oberhalb der untersten Modul-Reihe ■ nicht für 0,5 m Shop geeignet 	 <p>4 004764 962174</p>
<p>■ 51.766 LED Header Art.-Nr. 4-51766</p> 	<ul style="list-style-type: none"> ■ 1 Ersatz-LED-Schiene für Header 1 m 	 <p>4 004764 962181</p>
<p>■ 51.829 Nieten für Header Art.-Nr. 51829</p> 	<ul style="list-style-type: none"> ■ 4 weiße Niete mit Unterlegscheibe und Aufbauanleitung im Polybeutel 	 <p>4 004764 965298</p>
<p>■ 51.767 Rahmenleisten, rot Art.-Nr. 4-51767</p> 	<ul style="list-style-type: none"> ■ 2 Winkleisten, oben + unten ■ nicht für 0,5 m Shop geeignet 	 <p>4 004764 962198</p>

Header-Dias

51.700 POS Shop PBS – hoch

Art.-Nr.	Bezeichnung	EAN
4-51785	■ 51.785 POS Dia DE für DE + CH Variante	
4-51786	■ 51.786 POS Dia EN für Showroom Variante	
4-51787	■ 51.787 POS Dia FR für BeNeLux + CH Variante	
4-51788	■ 51.788 POS Dia NL für BeNeLux Variante	



51.701 POS Shop Premium – hoch

Art.-Nr.	Bezeichnung	EAN
4-51789	■ 51.789 POS Dia DE für DE + CH Variante	
4-51790	■ 51.7890 POS Dia EN für Showroom Variante	



51.702 POS Shop Creative – hoch

Art.-Nr.	Bezeichnung	EAN
4-51791	■ 51.791 POS Dia DE für DE Variante	
4-51792	■ 51.792 POS Dia EN für Showroom Variante	



Header-Dias

51.703 POS Shop Creative/Toys – hoch

Art.-Nr.	Bezeichnung	EAN
4-51793	■ 51.793 POS Dia DE für DE Variante	 4 004764 963195
4-51794	■ 51.794 POS Dia EN für Showroom Variante	 4 004764 963201



51.704 POS Shop PBS – medium

Art.-Nr.	Bezeichnung	EAN
4-51795	■ 51.795 POS Dia DE für DE Variante	 4 004764 963218
4-51796	■ 51.796 POS Dia EN für Showroom Variante	 4 004764 963225



51.705 POS Shop PBS kompakt – medium

Art.-Nr.	Bezeichnung	EAN
4-51797	■ 51.797 POS Dia DE für DE Variante	 4 004764 963232
4-51798	■ 51.798 POS Dia EN für Showroom Variante	 4 004764 963249
4-51799	■ 51.799 POS Dia FR für BeNeLux Variante	 4 004764 963256
4-51800	■ 51.800 POS Dia NL für BeNeLux Variante	 4 004764 963263



Etikettensätze

51.700 POS Shop PBS – hoch

Art.-Nr.	Bezeichnung	EAN
4-51805	■ 51.805 POS Etikettensatz DE für DE Variante	
4-51806	■ 51.806 POS Etikettensatz EN für Showroom Variante	
4-51807	■ 51.807 POS Etikettensatz FR für BeNeLux Variante	
4-51808	■ 51.808 POS Etikettensatz NL für BeNeLux Variante	



51.701 POS Shop Premium – hoch

Art.-Nr.	Bezeichnung	EAN
4-51809	■ 51.809 POS Etikettensatz DE für DE Variante	
4-51810	■ 51.810 POS Etikettensatz EN für Showroom Variante	



51.702 POS Shop Creative – hoch

Art.-Nr.	Bezeichnung	EAN
4-51811	■ 51.811 POS Etikettensatz DE für DE Variante	
4-51812	■ 51.812 POS Etikettensatz EN für Showroom Variante	



Etikettensätze

51.703 POS Shop Creative/Toys – hoch

Art.-Nr.	Bezeichnung	EAN	
4-51813	■ 51.813 POS Etikettensatz DE für DE Variante		
4-51814	■ 51.814 POS Etikettensatz EN für Showroom Variante		

51.704 POS Shop PBS – medium

Art.-Nr.	Bezeichnung	EAN	
4-51815	■ 51.815 POS Etikettensatz DE für DE Variante		
4-51816	■ 51.816 POS Etikettensatz EN für Showroom Variante		

51.705 POS Shop PBS kompakt – medium

Art.-Nr.	Bezeichnung	EAN	
4-51817	■ 51.817 POS Etikettensatz DE für DE Variante		
4-51818	■ 51.818 POS Etikettensatz EN für Showroom Variante		
4-51819	■ 51.819 POS Etikettensatz FR für BeNeLux Varianten		
4-51820	■ 51.820 POS Etikettensatz NL für BeNeLux Variante		

TEGO-Regale

Art.-Nr.	Bezeichnung	EAN
4-51779	51.779 Tego für POS Shop – hoch, 1 m breit	 4 1004764 963034
4-51780	51.780 Tego für POS Shop – hoch, 2 m breit	 4 1004764 963041
4-51781	51.781 Tego für POS Shop – medium, 2 m breit	 4 1004764 963058
4-51782	51.782 Tego für POS Shop – medium, 1 m breit	 4 1004764 963065



Abbildung ähnlich

Notizen

Notizen

Notizen

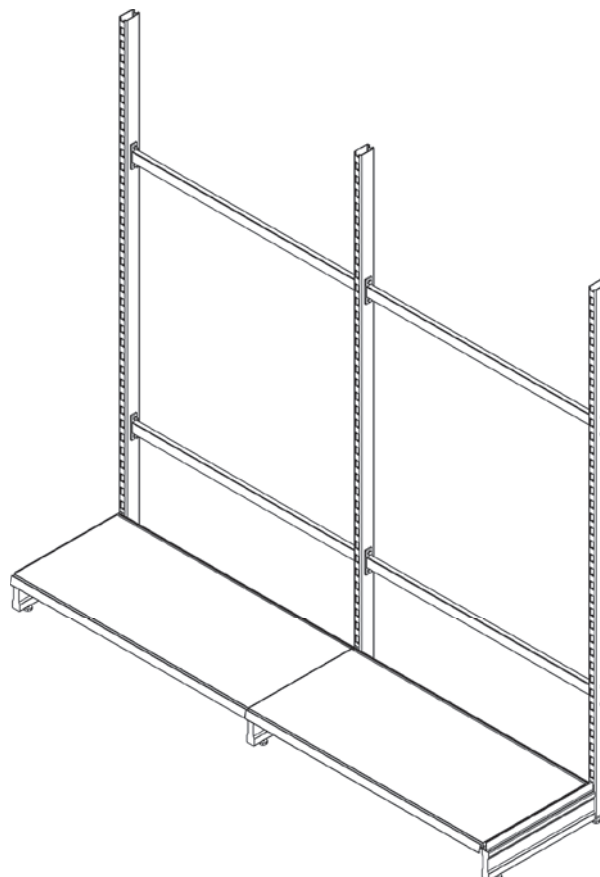